



Bearing Trust Promoting Happiness

# COMPANY INTRODUCTION



SINO-FOREIGN CHONGQING FUJI ELEVATOR CO., LTD.

- **China Headquarters address:**  
6F, Ideal Mansion, 1, Hongjin Avenue, Jiangbei District, Chongqing
- **China Chongqing factory:**  
Chongqing Dazu High-End Science and Technology Zone
- **China Ningbo production base:**  
Xiangshan, Ningbo, Zhejiang

Tel: +86-23-43333996 +86-13008338518  
E-mail: Melissa@fujickg.com Fred@fujickg.com  
Website: www.cqfujitech.com



2025 First edition

SINO-FOREIGN CHONGQING FUJI ELEVATOR CO., LTD.

Note: The sample content is for reference only. If there are any changes, please: No further notice will be given. For technical details, please feel free to call and inquire.

## Enterprise culture

Enterprise vision:  
to become the industry's advanced model of modern enterprise,  
cast a "quality" of the international brand elevator.

Core values:  
Bearing Trust Promoting Happiness

Enterprise purpose:  
customer satisfaction reputation for the continuous development of  
the growth of the staff

Enterprise policy:  
employee satisfaction with the brand as the first technology for the  
management of real

Enterprise spirit:  
integrity, harmony to open

Enterprise pursuit:  
to complete each elevator well, to be honest and trustworthy, to  
become a respected enterprise

## Enterprise idea

Talent concept:  
responsibility on Thanksgiving

Business philosophy:  
Build Brand With Integrity

Design concept:  
safe, reliable, thick, comfortable, energy saving, environmental protection,  
beautiful and generous.

Manufacturing concept:  
in a timely manner to improve the quality of the elevator

Marketing idea:  
when the elevator consultant God helps those who help themselves

General assembly concept:  
safety quality progress image

Service concept:  
safe and reliable prevention timely and efficient warm and thoughtful

Service concept:  
customer satisfaction as my friend

Communication philosophy:  
smiling Frank

Work style:  
today, things finish

## About us

Chongqing Fuji Elevator Co., Ltd. is a joint venture with advanced management system, covering the range from research and development, design, manufacturing, sales, installation, modification, maintenance to spare parts supply of elevators and escalators.

Founded in 1994, it succeeded to keep pace with the development of modern science and technology. By introducing the world's latest Fuji drive technology and focusing on continuous innovation, it became one of the world's most advanced elevator company. The company It has the National A-class Qualification of elevator manufacturing, installation, modification and maintenance. It is recognized as the National High-Tech Company, the member of the China Elevator Association, the Safety Production Standardization Enterprise, Chongqing Innovative Company, Chongqing High-Tech Product Enterprise and Chongqing Key New Product Enterprise. Recognized as a trustworthy quality unit nationwide, A company that honors contracts and maintains credibility, Participating unit of the National Elevator Standardization Technical Committee. It is the only 110 cooperation elevator company of Chongqing.

The company has obtained the certification of ISO 9001:2015 Quality Management System, ISO 14001:2015 Environmental Management System, ISO45001:2018 Occupation Health and Safety Management System, GB/T50430-2017 Construction Enterprise Quality Management System and VDI 4707 Elevator Energy Efficiency Grade A Certification. The full range of products are underwritten by well-known insurance institutions. The company was awarded by the Chongqing Municipal Bureau of Quality Supervision in 2015 the title of "Advanced Enterprise" in the renovation of old elevators. It is also awarded by the Chongqing Special Equipment Association Elevator Committee as the first place of the 2016 "Advanced Elevator Manufacturing Enterprises". It is recognized as the Chongqing Enterprise Technology Center in 2019.

Relying on the controlling shareholder Chongqing Sanli Industrial, the company combines the advantages of aviation resources and services of Western Airport Aircraft Maintenance Co., Ltd., Chongqing Airport Aircraft Maintenance Co., Ltd., and Chongqing Guorui Aviation Equipment Leasing Co., Ltd., which are the joint venture, holding and shareholding enterprises of Chongqing Fuji. In terms of elevator manufacturing, safety, quality and service, we learn from business aircraft maintenance standards, management concepts and safe release procedures. By creatively integrating aviation quality and service genes into elevators, we promote the continuous optimization and upgrading of the product and service quality throughout its life cycle.

The company adheres to the business philosophy of "Build Brand With Integrity" and strives to build three major technological linkage platforms, namely "management informatization, product intelligence and manufacturing intelligence". It adheres to the design concept of "safe and reliable, thick and comfortable, energy-saving and environmentally friendly, beautiful and elegant". In order to practice the purpose of "Serving customers wholeheartedly", the company cherishes every trust given by the market and customers and carefully producing every elevator, so that the product series created a good image among clients. The company aims to become an advanced modernization enterprise and an international famous elevator brand with a good sense.



# Intelligent Manufacturing



Sino-Foreign Chongqing Fuji Elevator Co., Ltd. relies on its "Integrated Management System, Intelligent Product System, and Smart Manufacturing Platform" - three interconnected technological platforms - to pursue a path of high-quality development. Just as tools are essential to craftsmanship, Sino-Foreign Chongqing Fuji has built a path to "smart manufacturing" by continuously attracting high-caliber manufacturing management talent and skilled production workers, establishing standardized production workshops, introducing advanced intelligent production equipment, and enhancing its manufacturing information management capabilities.



High precision CNC equipment, excellent quality protection.

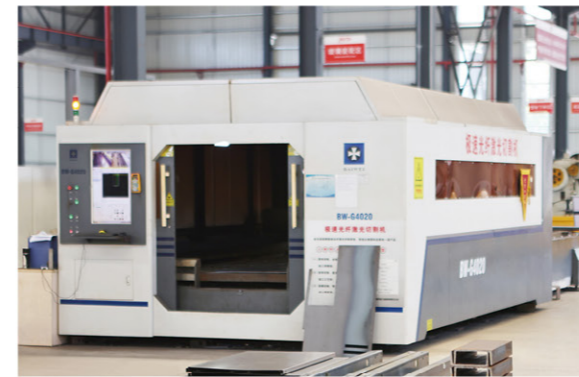

Ultra-Fast Fiber Laser Cutting Machine

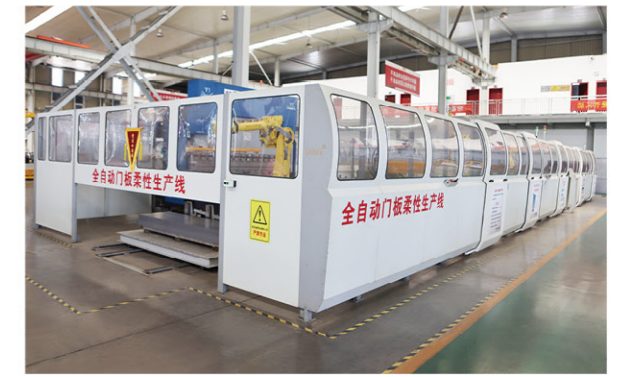

Fully Automated Flexible Door Panel Production Line



Fully Automated Reinforcing Rib Production Line



Fully Automated Door Frame Production Line



Fully Automated Shot Blasting Rust Removal Cleaner



Automated Paint Spraying Room

# Qualification certificate

**中华人民共和国台港澳侨投资企业  
批准证书**

**CERTIFICATE OF APPROVAL  
FOR ESTABLISHMENT OF ENTERPRISES WITH  
INVESTMENT OF TAIWAN, HONGKONG, MACAO AND  
OVERSEAS CHINESE IN THE PEOPLE'S REPUBLIC OF CHINA**

<b>企业名称</b> CHINESE NAME OF ENTERPRISE	中文 重庆富士电梯有限责任公司		
	ENGLISH CHONGQING FUJI ELEVATOR CO., LTD		
<b>企业地址</b> ADDRESS	重庆市江北区红锦大道1号理想大厦6楼		
<b>企业类型</b> TYPE OF BUSINESS	中外合资企业 (外资比例小于25%)	<b>经营年限</b> DURATION OF OPERATION	伍拾年
<b>投资总额</b> TOTAL INVESTMENT	贰亿零叁佰万元人民币		
<b>注册资本</b> REGISTERED CAPITAL	贰亿零叁佰万元人民币		
<b>经营范围</b> BUSINESS SCOPE	生产、销售电梯及零部件, 并进行安装、维保和售后服务。		
<b>批准号</b> APPROVAL NUMBER	商外资渝字[1994]0155号	<b>投资者名称(中、英文)</b> NAME OF INVESTORS (IN CHINESE AND ENGLISH)	<b>注册地</b> PLACE OF REGISTRATION
<b>进出口企业代码</b> CODE FOR IMPORT AND EXPORT ENTERPRISE	5000621910373	重庆三力建筑安装工程有限公司 日本富士电梯株式会社有限公司	中国 香港
<b>批准日期</b> DATE OF APPROVAL	一九九四年	<b>出资额</b> CAPITAL CONTRIBUTION	出资19720万元人民币 出资580万元人民币等值港元
<b>发证日期</b> DATE OF ISSUE	二〇一四年		
<b>发证序号</b> ISSUE NUMBER	5000009985		

# Some Of Our Partners

**中华人民共和国  
特种设备生产许可证**

Production License of Special Equipment  
People's Republic of China

编号: TS2310339-2026

单位名称: 重庆富士电梯有限责任公司  
住所: 重庆市大渡口区万丰工业园区  
制造地址: 重庆市大渡口区万丰工业园区

经审查, 获准从事以下特种设备生产活动:

许可项目	许可类别	备注
曳引驱动载客电梯(含无机房电梯)	A	特种设备型式试验合格
曳引驱动载货电梯和杂物电梯(含无机房电梯)	A	特种设备型式试验合格
自动扶梯与自动人行道	A	特种设备型式试验合格
杂物电梯(含无机房杂物电梯)	A	特种设备型式试验合格

发证机关: 国家市场监督管理总局  
有效期至: 2026年03月23日

**TÜV Rheinland**

Industrial Services  
Industrielle Dienstleistungen

Product No.: 0226295-001    Auftrags-Nr.: 33007912    Seite 1 von 2  
Test Reference No.: 26-12085    Auftragsdatum: 21.08.2024    Page 1 of 2

Client: CHONGQING FUJI ELEVATOR CO., LTD  
WANGJIA INDUSTRIAL PARK, QIANJUN DISTRICT, 402656 Chongqing P.R. China

Product: Passenger lift

Identification / Type No.: CP-1P8300

Energy efficiency test according to EN 12015-1:2023 and EN 12015-2:2023

Test specification: ISO 2746-1:2023

Test date: 2024.08.24

Test result: **A**

Tested by: Zhen Chen / PE

Authorised by: Barton Quen / Authoriser

**TÜV Rheinland**

Industrial Services  
Industrielle Dienstleistungen

Product No.: 0226295-001    Auftrags-Nr.: 33007912    Seite 1 von 2  
Test Reference No.: 26-12085    Auftragsdatum: 21.08.2024    Page 1 of 2

Client: CHONGQING FUJI ELEVATOR CO., LTD  
WANGJIA INDUSTRIAL PARK, QIANJUN DISTRICT, 402656 Chongqing P.R. China

Product: Passenger lift

Identification / Type No.: CP-1P8300

Energy efficiency test according to VDA 4707 Part 1

Test specification: VDA 4707 Part 1

Test date: 2024.08.24

Test result: **A**

Tested by: Zhen Chen / PE

Authorised by: Barton Quen / Authoriser

**CERTIFICATE OF CONFORMITY OF  
QUALITY MANAGEMENT SYSTEM CERTIFICATION**

We hereby certify that  
**Chongqing FUJI Elevator Co., Ltd.**  
(Uniform Social Credit Code: 91500103621910373)

Registration Address: Wanshan Industrial Park, Daxu District, Chongqing, China.  
Postal Code: 400026

By means of the  
**Quality Management System**  
has been awarded this certificate for  
compliance with the standard:  
**GB/T19001-2016/ISO 9001:2015**

The quality management system applies in the following area:  
*The quality management system in the design, manufacturing, installation, operation, maintenance and after-sales service according to the classification of passenger elevators, freight elevators, with or without machine room, the Chongqing FUJI Elevator Co., Ltd. located on the 6th floor of Huanan Avenue 11thm Building in Shusheng District, Chongqing, and the production workshop located at No.798 Chongqing Avenue in Wanshan Industrial Park, Daxu District, Chongqing, China.*

Registration No.: 019242103608404  
Issue date: 26/23, 2024  
Expiration date: May 25, 2027

**CERTIFICATE OF CONFORMITY OF OCCUPATIONAL HEALTH  
AND SAFETY MANAGEMENT SYSTEM CERTIFICATION**

We hereby certify that  
**Chongqing FUJI Elevator Co., Ltd.**  
(Uniform Social Credit Code: 91500103621910373)

Registration Address: Wanshan Industrial Park, Daxu District, Chongqing, China.  
Postal Code: 400026

By means of the  
**Occupational Health and Safety Management System**  
has been awarded this certificate for  
compliance with the standard:  
**GB/T45001-2020/ISO 45001:2018**

The occupational health and safety management system applies in the following area:  
*The occupational health and safety management system in the design, manufacturing, installation, operation, maintenance and after-sales service according to the classification of passenger elevators, freight elevators, with or without machine room, the Chongqing FUJI Elevator Co., Ltd. located on the 6th floor of Huanan Avenue 11thm Building in Shusheng District, Chongqing, and the production workshop located at No.798 Chongqing Avenue in Wanshan Industrial Park, Daxu District, Chongqing, China.*

Registration No.: 019242103628451  
Issue date: 26/23, 2024  
Expiration date: May 25, 2027

**CERTIFICATE OF CONFORMITY OF ENVIRONMENTAL  
MANAGEMENT SYSTEM CERTIFICATION**

We hereby certify that  
**Chongqing FUJI Elevator Co., Ltd.**  
(Uniform Social Credit Code: 91500103621910373)

Registration Address: Wanshan Industrial Park, Daxu District, Chongqing, China.  
Postal Code: 400026

By means of the  
**Environmental Management System**  
has been awarded this certificate for  
compliance with the standard:  
**GB/T24001-2016/ISO 14001:2015**

The environmental management system applies in the following area:  
*The environmental management system in the design, manufacturing, installation, operation, maintenance and after-sales service according to the classification of passenger elevators, freight elevators, with or without machine room, the Chongqing FUJI Elevator Co., Ltd. located on the 6th floor of Huanan Avenue 11thm Building in Shusheng District, Chongqing, and the production workshop located at No.798 Chongqing Avenue in Wanshan Industrial Park, Daxu District, Chongqing, China.*

Registration No.: 019242103618454  
Issue date: 26/23, 2024  
Expiration date: 26/24, 2027

# Core components Original factory Original brand

## Permanent magnet synchronous and gearless traction machine

It chooses the rare earth materials to fully merge the coaxial drive technology, the numeric variable frequency technology, the group-computer combined control technology with the efficient energy-saving, minimum travel cost, low heat dissipation, extremely high work efficiency, Compared with the common traditional techniques, it can save more than 40% of the energy. And the gearless traction machine needs no renewal of the grease without any oil pollution. The low noise design produces a peaceful riding space for you.

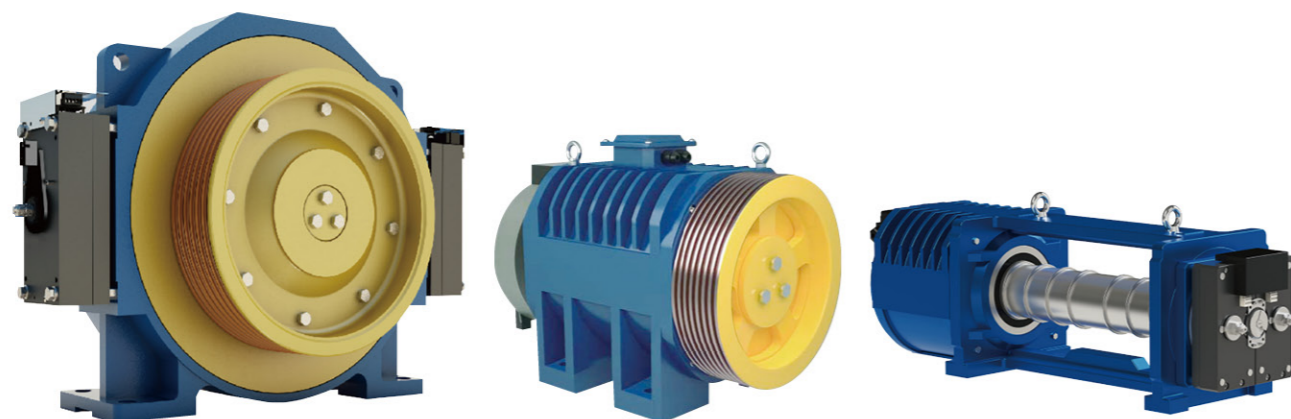

## Efficient vector elevator dedicated control system

Application of high performance current vector control and absolute encoders, high-performance sensorless torque compensation function which make the elevator ride more comfortable; elevator traction machine can be self-learning, more simple and convenient elevator maintenance; automatic transfer torque boost function can easily cope with a variety of elevator load.

The drive automatically calculates the time, the shortest time for positioning. Reduce the crawling time, the elevator run more efficiently, more smoothly. Short floors run function, automatically minimize the creeping time.

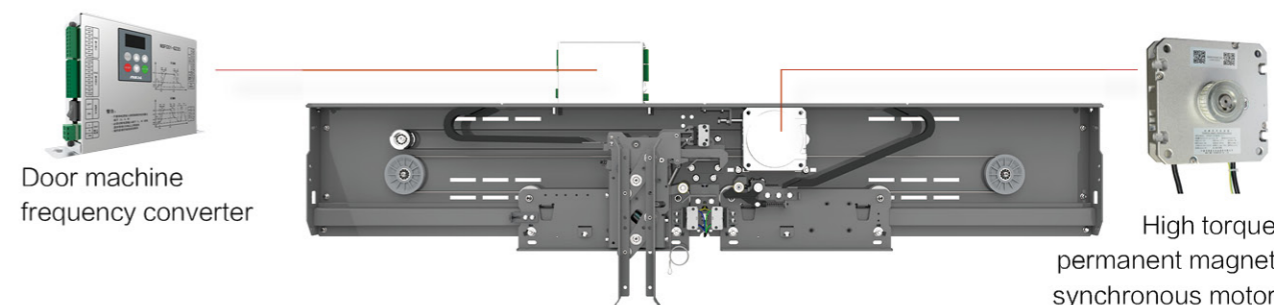

## Permanent magnet synchronous inverter gate machine

Permanent magnet synchronous inverter gate machine adopts the latest technology magnet frequency vector control, closed loop control, real-time monitoring door travel case; reliability, curve smooth and comfortable; compact, high utilization hoistway; General performance is strong; adopts timing transmission is steady low noise. Light curtain protection system is a high performance two-dimensional screens contactless door protection systems. Protect passengers unobstructed access, ride safely.



## Governor

Governor is one of the safety control components in the elevator safety protection system. When the elevator cabin experiences overspeed or even the risk of falling for any reason during operation, and all other safety devices fail to function, the governor and the safety gear will activate simultaneously to stop the elevator cabin.



## Safety Gear

Safety gear is a safety protection device for elevators. Under the control of the governor, when the elevator speed exceeds the limit (or rated) speed set by the governor, or in the event of a suspension rope break or slack, the safety gear will perform an emergency stop on the cabin and hold it against the guide rails. It provides effective protection for the safe operation of the elevator and is generally installed on the cabin frame or counterweight frame.



## Buffer

Buffer is an indispensable part of the elevator safety system. Its main function is to provide final physical protection in any abnormal situation during elevator operation, such as wire rope breakage, insufficient traction, inadequate brake force, or control system failure, preventing the elevator cabin or counterweight from directly impacting the bottom or top of the hoistway, ensuring the safety of passengers and equipment.

## Advanced technology

### Intelligent network cloud data monitoring center

Chongqing Fuji Elevator regularly sends personnel to inspect the operation status of your equipment, which will ensure the most professional maintenance of your equipment. By using Internet of Intelligences technology to monitor and collect elevator operation data in real-time 24/7, and summarizing it on the monitoring platform server, dynamic data analysis is used to achieve intelligent comprehensive management functions such as elevator operation monitoring, fault alarm, rescue of trapped people, automatic voice comfort for trapped people, remote two-way communication (between passengers and management center), networked backend dispatch system, daily management, quality assessment, hidden danger prevention, big data analysis system, and automatic recording of emergency repairs and maintenance.

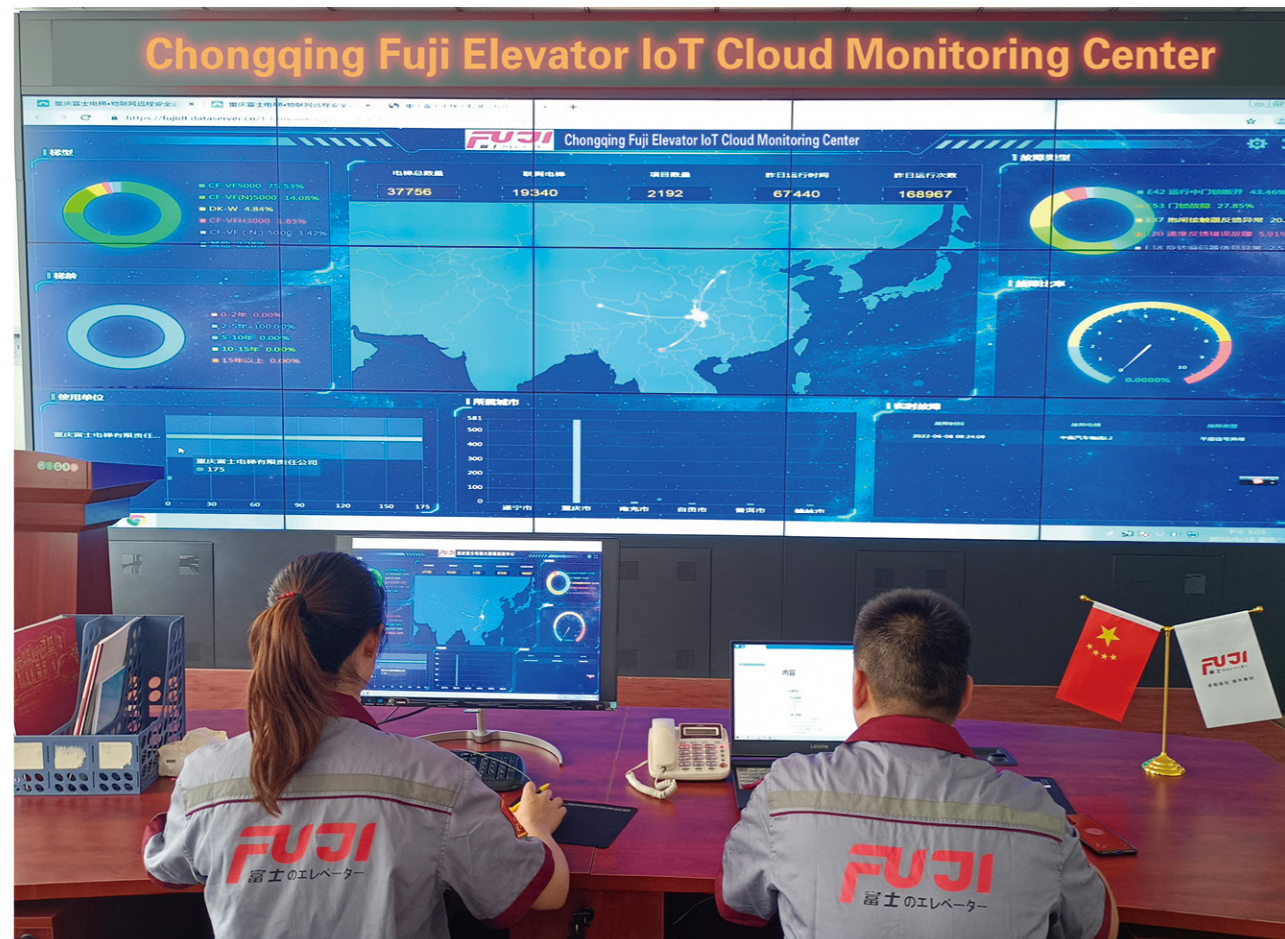

### Sensitive servo, smooth passage: waterproof infrared light curtain

As a safety protection network on car door, infrared light curtain can give sensitive response to both passenger and cargo into its detection plane, and lowers occurrence of "pinching". Waterproofed infrared light curtain is better in durability and brings more considerate protection.



### Frame protection, multi-level reassurance: frame-type car structure

At parking on the first floor, impact on bottom of car from bottom of hoistway can be effectively reduced, which better protects personal safety of passenger.



### Efficient Group Control Management

#### UPS/DPS

Efficient group control can intelligently dispatch elevators according to different traffic conditions, greatly reducing passenger waiting time and passenger time.

#### UPS/DPS peak hours service

During rush hour service hours, priority should be given to continuously dispatching elevators to the designated floor stations to meet peak operational needs.

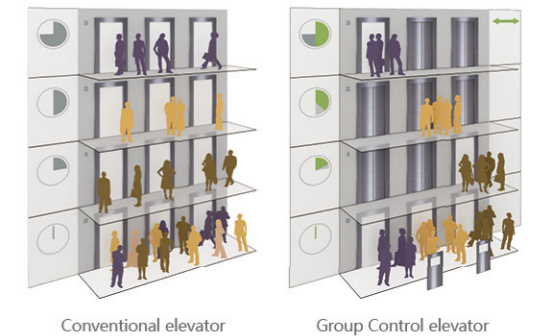

### LED Energy-Saving Lighting System

Adopting DC drive and ultra-low power consumption LED as the lighting fixture for the car interior. The electro-optical power conversion is close to 100%, and the same lighting effect saves more than 80% energy compared to traditional light sources. When there is no one calling the elevator, the lighting inside the car will automatically turn off. When a passenger calls, the equipment will automatically start. Using LED lights is more energy-efficient and has a longer lifespan.



# Advanced technology

## Video Intercom System

The new generation of Two-Way Video Intercom System supports the visual communication between people inside and outside the car, between cars, between the car and the control room as well as between the car and the outside maintenance personnel, realizing the seamless emergency call function. At the same time, with the help of intercom cameras, trapped people in the car can be detected and the video intercom would be automatically activated on such occasions, realizing the visualized rescue.



## Car Space Purification Solution

Elevator is equipped with exclusively developed environment-friendly car fan, which can supply purified air, remove PM2.5, kill virus, purify air, provide healthy and clean air for passengers; Removing dust (PM2.5) and mold from the air while sending air into car; Through the circulated air purification within the elevator, virus in the air are continuously killed, especially the flu virus, reducing the probability of flu spread in the elevator. (UV disinfection is proved to be effective against the Covid-19); Through the circulated air purification within the elevator, the air in the elevator is continuously purified and removed of various odors such as smoke and volatile organic compounds.



## Antibacterial Button

This extended development is completed on the basis of mechanical buttons. The parts in contact with the human body use antibacterial materials with a high antibacterial durability.



## Intelligent Voice Call System

Health and safety Intelligent voice call technology  
Zero-contact is the correct way to protect you from the epidemic



Real-time responsiveness, immediate response

## IC Card and Face Recognition System

Smart card Smart floor selection Face recognition  
Zero-contact is the correct way to protect you from the epidemic



## Fingerprint Recognition

After registering the fingerprint correctly, you can authorize the corresponding floor and the password can be set to take the elevator while the fingerprint is valid; after the valid fingerprint or password is verified, the corresponding permission floor can be automatically registered, which contributes to intelligence, environmental protection, health, and safety;



## Mobile Phone Bluetooth, NFC function and QR Code Control System

Easy Authorization Fast Installation Stylishness  
Zero-contact is the correct way to protect you from the epidemic

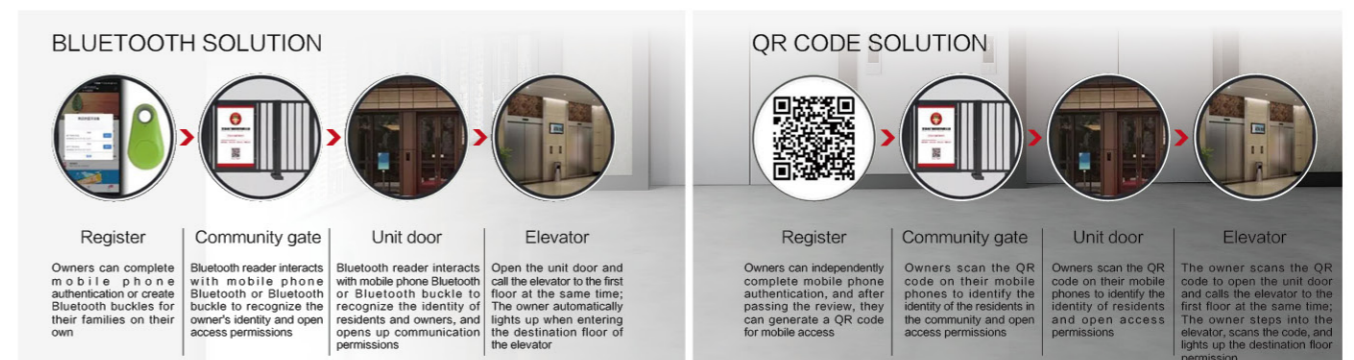

# Passenger elevator car decoration



**FJ CAR301A**



Car walls	Hairline stainless steel + Intermediate wall mirror stainless steel
Integral spray ceiling	C395 Stainless steel + LED ring lamp + LED Spotlight
Handrail	H300 Mirror stainless steel single tube (optional)
Floor	Super wear-resistant parquet PVC flooring (standard) Marble parquet flooring (optional)



**FJ CAR366**



Car walls	Titanium gold hairline stainless steel + middle left and right side of the car wall mirror stainless steel + Intermediate wall mirror stainless steel + Light strip
Ceiling	Titanium gold hairline stainless steel + Light strip + LED Spotlight
Handrail	Titanium gold three pipes handrail (optional)
Floor	Super wear-resistant parquet PVC flooring (standard) Marble parquet flooring (optional)



**FJ CAR361**



Car walls	Hairline stainless steel + Intermediate wall mirror stainless steel
Integral spray ceiling	Stainless steel + Spotlight
Handrail	H300 Mirror stainless steel single tube (optional)
Floor	Super wear-resistant parquet PVC flooring (standard) Marble parquet flooring (optional)

**FJ CAR367**



Car walls	Bronze titanium stainless steel + middle left and right side of the car wall bronze titanium mirror stainless steel + Intermediate wall bronze titanium mirror stainless steel + glass
Ceiling	Bronze mirror stainless steel + acrylic
Floor	Super wear-resistant parquet PVC flooring (standard) Marble parquet flooring (optional)



# Panoramic elevator car decoration



560



Car walls	Mirror titanium etched stainless steel+Mirror titanium stainless steel+ Safety laminated glass
Ceiling	Titanium stainless steel + acrylic lamp decoration
Handrail	Titanium-plated stainless steel round tube
Floor	PVC



564



Car walls	Titanium mirror stainless steel+Safety laminated glass
Car Cover	Titanium mirror stainless steel, Acrylic
Ceiling	Titanium mirror stainless steel frame Top gold foil veneer Downlight
Handrail	Titanium stainless steel round tube
Floor	Marble Mosaic

552



Car walls	Stainless Steel Hairline Board+Three Glue Glass of Safety Clamp
Car Cover	Steel Plate Sparying
Ceiling	Image Board with Tube Lamp Round
Handrail	Pair Tube Stainless Steel
Floor	PVC



563



Car walls	Hairline stainless steel + laminated glass
Ceiling	Hairline stainless steel + acrylic lamp decoration + downlight
Handrail	Round brushed stainless steel tube
Floor	PVC imitation marble



# Villa elevator car decoration



**CAR350 Standard**



Car Show

Car walls	Front wall: Hairline stainless steel Side wall: Hairline stainless steel Rear wall: Mirror stainless steel
Ceiling	Mirror stainless steel, middle acrylic transparent plate, spotlight
Car door	Hairline stainless steel
Floor	Standard wear-resistant PVC (Optional parquet marble)



**CAR395 Optional**



Car Show

Car walls	Front wall: Black titanium hairline stainless steel Side wall: Black titanium hairline stainless steel + Mirror stainless steel + LED strip
Ceiling	Black titanium Mirror stainless steel, LED strip
Car door	Black titanium hairline stainless steel
Floor	Standard wear-resistant PVC (Optional parquet marble)



**CAR360 Optional**



Car Show

Car walls	Front wall: Titanium hairline stainless steel Side wall: Titanium hairline stainless steel, titanium mirror etching Rear wall: Titanium hairline stainless steel, titanium mirror etching
Ceiling	Titanium mirror stainless steel, spotlight
Car door	Titanium hairline stainless steel
Floor	Standard wear-resistant PVC (Optional parquet marble)

**CAR382 Optional**



Car Show

Car walls	Front wall: Sandblasted titanium stainless steel Side wall: Sandblasted titanium stainless steel, glued safety glass Rear wall: Sandblasted titanium stainless steel, glued safety glass
Ceiling	Mirror Stainless Steel, LED Tube Lamp
Car door	Sandblasted titanium stainless steel, glued safety glass
Floor	Standard wear-resistant PVC (Optional parquet marble)



# Freight elevator car decoration

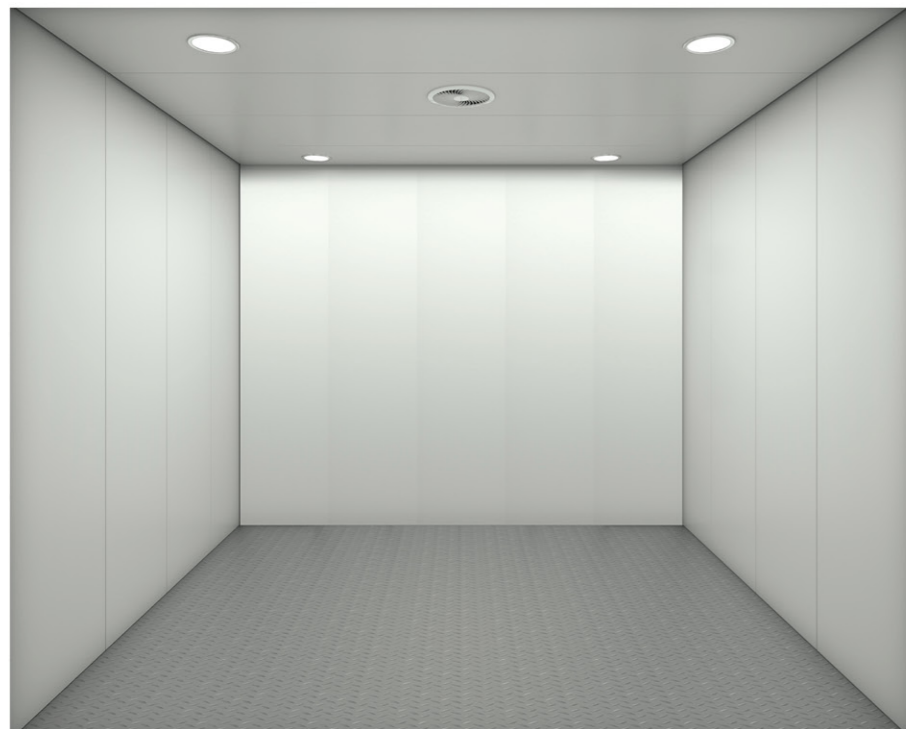

**CF-H01**  
Standard



Car walls	Paint steel (optional color)
Ceiling	Paint steel (optional color)+LED lamp
Car door	Paint steel (optional color)
Floor	Riffled plate

**CF-H02**  
Optional



Car walls	Hairline stainless steel
Ceiling	Hairline stainless steel+LED lamp
Car door	Hairline stainless steel
Floor	Riffled plate

## Product System

### Passenger Elevator

- Small machine-room elevator
- machine-room-less elevator · home elevator
- business elevator · express elevator · bed elevator

Based on human orientation, technology strength and design, it applies the new generation permanent magnet synchronous gearless traction machine and computer control technology. Combined with the integrates data networked system and modularization structure, the most effective self-check program helps to achieve a more flexible, accurate, effective and reasonable elevator control system.



### Panoramic Elevator

- Machine-room-less panoramic elevator
- Machine-room panoramic elevator

Its noble and elegant appearance adds to the luster of your building, and passengers can have a broader range of vision when appreciating the scenery outside the elevator from multiple perspectives. External lighting on the car blends into the surroundings, which makes the panoramic elevator a beautiful scene. CHONGQING FUJI panoramic elevators add to the buildings' personality and vitality. Sightseeing elevator will always be center of attraction and attention whether from outdoor or indoor; passengers can appreciate the architectural art and surrounding scenery with ease; its dynamic shape becomes the scenery that flows on the building. Resplendent and magnificent circular sightseeing elevator is the elevator with classical indoor opening design; the circular car and down-lighting illumination bring about the feeling of future world. We also provide sightseeing elevators in type of right angle, semicircle, incise angle and so on to match various buildings and reflect its unique luster.



### Bed Elevator

- Machine-room-less bed elevator
- Machine-room bed elevator

CHONGQING FUJI bed elevator is not only used to convey passengers for public purpose, but also has special and strict requirements on the functional performance due to special use purpose. Speed of CHONGQING FUJI bed elevator can be accurately controlled to ensure smooth and comfort operation. Design of CHONGQING FUJI bed elevator focuses on humanization to fully optimize car structure to meet customer requirements to the largest degree. It creates a quiet and elegant space for passengers. With its unique design concept, CHONGQING FUJI bed elevator creates a clean and bright space that is in harmony with hospital environment, which makes the passengers comfortable and gives the patients the confidence to recover.



### Home Elevator

- Traction type home elevator
- Hand door home elevator
- Automatic door home elevator

CHONGQING FUJI home elevator continues to adopt top technology in the field of private elevator, inherits international classical design concepts and integrates artistry, practicality and contemporaneity into one, which matches the taste of villa and private mansion perfectly.

## Product System

### Goods elevator

- Machine-room-less goods elevator
- Machine-room goods elevator

Knowing the concept of energy saving and consumption reduction, CHONGQING FUJI goods elevator improves the freedom degree of design and it fully reflects the idea of green and low carbon while saving construction area. Compared with goods elevator with the same load capacity, which is equipped with machine room, this elevator saves electric energy by 25% and building area by 10%.



### Automobile elevator

FUJI automobile elevator gives a full use of the years' automobile manufacture technology from Japan FUJI Company. It applies the highly well-developed variable voltage, variable frequency control technology, precise speed governor control. It avoids noids and car-shake due to enlarged burden of traction system because of uneven encountered force to the car. It optimizes the characteristics of this series to the greatest extent.



### Escalator

- 30° indoor small high-rise escalator
- 35° indoor small high-rise escalator
- 30° indoor medium high-rise escalator
- 30° outdoor small high-rise escalator
- 35° outdoor small high-rise escalator
- 35° outdoor median high-rise escalator
- 30° outdoor bus-type escalator
- 30° indoor bus-type escalator

The escalators of CHONGQING FUJI adopt the new type materials and advanced technology from abroad. It has delicate structure and elegant appearance. It is suitable for shopping malls, supermarkets, underground stations, airports and other places with large traffic flow. And it will add to the scenery of buildings.

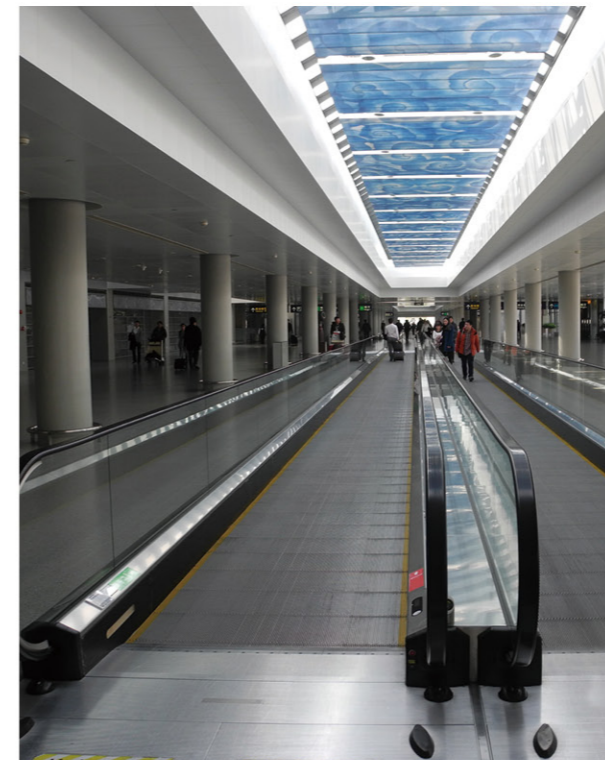

### Moving walk

- Moving Walk(indoor)
- Moving Walk(outdoor)

The moving walk of CHONGQING FUJI brings about a new comfortable experience. It can not only solve the problem of large traffic flow, can but also meet the requirements of long distance walking, conveying luggage, baby carriage, shopping cart, wheel chair and so on, which brings about great convenience for people.

## Meticulous Assembly

Implementing the overall assembly concept of quality, safety, progress, image, and aesthetics, we have created numerous elevator model projects and premium engineering works.

We have over 50 A-level installation teams with more than 15 years of experience in elevator installation and renovation, trained through our own system and qualified through assessments.

A comprehensive safety and technical briefing mechanism ensures that construction personnel understand the project design and customer-specific requirements.

We have a robust quality assurance system, continuously optimized installation processes, personalized construction plans, and strict control of key processes. Through individual self-inspection, team mutual inspection, process special inspection, completion factory inspection, supervision follow-up inspection, government special inspection, and maintenance handover inspection, we ensure reliable installation quality.

We prepare and control construction schedules based on customer needs, ensuring safe and civilized construction to guarantee timely, quality, and safe completion.



## Towards a Better Future

Chongqing Fuji Elevator is heavy, safe, reliable, and comfortable, becoming a modern advanced model enterprise in the industry and forging a tasteful international brand elevator. With thirty years of craftsmanship inheritance and steady progress, we have persevered, innovated, and climbed to new heights.

In the glorious journey of the past thirty years, we have built our brand on integrity and collaboration. We have always adhered to the philosophy of meticulous manufacturing, careful assembly, attentive maintenance, and sincere cooperation, serving over 6,000 customer units and more than 30,000 elevator engineering projects, creating numerous model projects and premium works.

Looking to the future, in the new thirty years, we carry trust, enhance beauty, and continuously deliver products and services favored by the market and trusted by customers. We will continue to build a value-win-win system of mutual support and achievement. On the road to the future, the road to excellence, we are grateful to our customers and will move forward together towards a better future—beautiful products, excellent services, and fruitful cooperation!



## After-sales service

With first-class technical innovation ability, international management experience and excellent services, Chongqing Fuji Elevator provides products with scientific maintenance and strict quality control. Choosing Chongqing Fuji Elevator is to choose a complete service system.

Based on the experience of maintenance standards, management concepts and safety release procedures of large commercial passenger aircraft, integrating innovation into aviation quality and service genes, Chongqing Fuji elevator will continue to optimize and upgrade its high-quality construction in the field of after-sales service.

The company adheres to the corporate mission of "Serving Customers with Full Commitment," practicing the maintenance philosophy of "Safety and Reliability, Prevention First, Timely and Efficient, Enthusiastic and Thoughtful." We have established a competent and efficient professional maintenance team, a nationwide after-sales service network, and a spare parts supply system to provide customers with 24-hour "all-weather, worry-free" service. We ensure that every passenger riding Chongqing Fuji Elevator enjoys a relaxed and pleasant "journey"!



In order to urgently remove the problems, Chongqing Fuji elevator specially sets 24-hour national service hotline. We provide you with aid service at the first moment.